

CORONÉO
CATALOG

2013

TABLE OF CONTENTS

COR-VASC SYSTEMS	5
COR-VASC SYSTEM (LG) "ORIGINAL" WITH LARGE STERNUM RETRACTOR	5
COR-VASC SYSTEM (SM) "ORIGINAL" WITH SMALL STERNUM RETRACTOR	5
COR-VASC SYSTEM (LG) "ARTICULATED ARM" WITH LARGE STERNUM RETRACTOR	5
COR-VASC SYSTEM (SM) "ARTICULATED ARM" WITH SMALL STERNUM RETRACTOR	5
COR-VASC SYSTEM - ASSEMBLIES	6
STERNUM RETRACTOR (LG)- LARGE	6
STERNUM RETRACTOR (SM)- SMALL	6
UNIVERSAL CLAMPING ASSEMBLY	6
"ORIGINAL" HEART STABILIZER KIT	6
ARTICULATED ARM SYSTEM	6
ARTICULATED ARM & ACCESSORIES	6
STABILIZER WITH PEDESTALS	6
STABILIZER WITHOUT PEDESTALS	6
STABILIZER WITH PEDESTALS – SHORT	6
COMPACT STABILIZER - INTERCOSTAL – FLAT	7
DIAPHRAGM DEFLECTOR BLADE	7
UNIVERSAL INSTRUMENT-MOUNTING ACCESSORIES	7
UNIVERSAL ADAPTOR	7
CORONARY VESSEL OCCLUSION PRODUCTS	8
SWIFT-LOOP PLEDGET FORCEPS	8
SWIFT-LOOP VESSEL LOOP WITH BLUNT NEEDLE & PLEDGET	8
SWIFT-LOOP VESSEL LOOP WITH BLUNT NEEDLE	8
SWIFT-LOOP VESSEL LOOP FOR ROBOTIC SURGERY WITH BLUNT NEEDLE & PLEDGET	8
INTERCOSTAL COR-VASC SYSTEMS	9
INTERCOSTAL COR-VASC SYSTEM	9
INTERCOSTAL COR-VASC SYSTEM - ASSEMBLIES	9
DETACHABLE BLADE RETRACTOR	9
DETACHABLE BLADE SET – 3 CM	9
DETACHABLE BLADE SET – 5 CM	9
DETACHABLE BLADE SET – 7 CM	9
UNIVERSAL CLAMPING ASSEMBLY	9
INTERCOSTAL COR-VASC SYSTEM - ASSEMBLIES (CONTINUED)	10
INTERCOSTAL STABILIZER	10
INTERCOSTAL COR-VASC SYSTEM - ACCESSORIES	10
COMPACT STABILIZER - INTERCOSTAL – FLAT	10
COMPACT STABILIZER – INTERCOSTAL – BENT	10
COR-VALV SYSTEMS	11
COR-VALV SYSTEM- LARGE	11
COR-VALV SYSTEM - SMALL	11
COR-VALV SYSTEM – SMALL WITH ATRIAL RETRACTOR ONLY	11
COR-VALV SYSTEM – LARGE WITH ATRIAL RETRACTOR ONLY	11
COR-VALV SYSTEM - ASSEMBLIES	11

TABLE OF CONTENTS



STERNUM RETRACTOR (LG)	11
STERNUM RETRACTOR (SM)	11
UNIVERSAL CLAMPING ASSEMBLY	11
COR-VALV KIT	11
COR-VALV SYSTEM - ACCESSORIES	12
ARTICULATED ARM SYSTEM	12
ATRIAL DEFLECTOR – SINGLE BLADE	12
CABLE – ATRIAL RETRACTOR	12
CABLE – AORTIC RETRACTOR	12
INTERCOSTAL MITRAL VALVE SURGERY SYSTEMS	13
INTERCOSTAL MITRAL COR-VALV SYSTEM	13
INTERCOSTAL MITRAL VALVE SURGERY SYSTEM - ASSEMBLIES	13
DETACHABLE BLADE RETRACTOR	13
DETACHABLE BLADE SET – 3 CM	13
DETACHABLE BLADE SET – 5 CM	13
DETACHABLE BLADE SET – 7 CM	13
UNIVERSAL CLAMPING ASSEMBLY	13
INTERCOSTAL ATRIAL RETRACTOR	13
INTERCOSTAL MITRAL VALVE SURGERY SYSTEM - ACCESSORIES	14
LINKAGE ASSEMBLY – TMVR 60 MM	14
LINKAGE ASSEMBLY – TMVR 42 MM	14
LINKAGE ASSEMBLY – AORTIC INTERCOSTAL	14
INTERCOSTAL RETRACTOR TUBING ASSEMBLY	14
RETRACTOR OBTURATOR	14
CABLE FOR INTERCOSTAL ATRIAL RETRACTOR (BOX OF 10 INDIVIDUALLY POUCHED STERILE CABLES) SINGLE USE	14
PEDIATRIC RETRACTORS	15
PEDIATRIC SWIVEL RETRACTOR - INFANT	15
PEDIATRIC SWIVEL RETRACTOR - NEONATE	15
SUB-ASSEMBLIES	16
STERNUM RETRACTOR (LG)	16
<i>Spreader Arm – rack side – large</i>	16
<i>Spreader Arm – crank side – large</i>	16
<i>Pinion</i>	16
STERNUM RETRACTOR (SM)	16
<i>Spreader Arm – rack side – small</i>	16
<i>Spreader Arm – crank side – small</i>	16
<i>Pinion</i>	17
HEART STABILIZER KIT	17
<i>Push-Type Stabilizer – right angle</i>	17
<i>Push-Type Stabilizer – obtuse angle</i>	17
<i>Pull-Type Stabilizer – left hand bend</i>	17
<i>Pull-Type Stabilizer – right hand bend</i>	17
ARTICULATED ARM ASSEMBLY	18
<i>Jaw and Cable Assembly – articulated arm</i>	18
<i>Cable – refurbishment</i>	18
<i>Cable Assembly – refurbishment</i>	18
<i>Cam Lock Assembly</i>	18
<i>Post Assembly</i>	18
DETACHABLE BLADE RETRACTOR	19

TABLE OF CONTENTS

<i>Detachable Blade Retractor – crank side</i>	19
<i>Detachable Blade Retractor – rack side</i>	19
<i>Pinion</i>	19
INTERCOSTAL STABILIZER	20
<i>Cable Tension Adjuster – articulated arm</i>	20
<i>Cam Lock Assembly</i>	20
<i>Cable Assembly</i>	20
<i>Straight Tubular Housing</i>	20
<i>Bent Tubular Housing</i>	20
<i>Compact Stabilizer – Intercostal - Bent</i>	20
<i>Trocar Tip - .156 inch</i>	20
<i>Cable Hook</i>	20
COR-VALV KIT (SERIES LG) ASSEMBLY	21
<i>Housing – aortic retractor</i>	21
<i>Housing – atrial retractor</i>	21
COR-VALV TISSUE RETRACTOR – SPECIAL ORDER	21
<i>Housing – atrial retractor – Trans-septal approach</i>	21
PEDIATRIC SWIVEL RETRACTOR - INFANT	22
<i>Crank side for Infant Retractor</i>	22
<i>Rack side for Infant Retractor</i>	22
<i>Pinion for Pediatric Retractors</i>	22
PEDIATRIC SWIVEL RETRACTOR - NEONATE	22
<i>Crank side for Neonate Retractor</i>	22
<i>Rack side for Neonate Retractor</i>	22
<i>Pinion for Pediatric Retractors</i>	22
INDEX	23



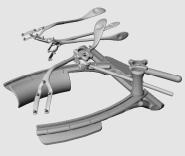
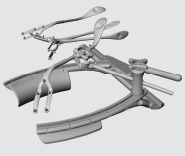

BEATING HEART CABG SURGERY

Cor-Vasc Systems

	Product No.	Product Description	Price (euro)
	1100010	<i>Cor-Vasc System (LG) “Original” with Large Sternum Retractor</i>	
	1100020	<i>Cor-Vasc System (SM) “Original” with Small Sternum Retractor</i>	
	1100229	<i>Cor-Vasc System (LG) “Articulated Arm” with Large Sternum Retractor</i>	
	1100230	<i>Cor-Vasc System (SM) “Articulated Arm” with Small Sternum Retractor</i>	

BEATING HEART CABG SURGERY

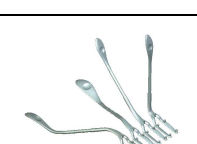

Cor-Vasc System - Assemblies

	Product No.	Product Description	Price (euro)
	1100214	Sternum Retractor (LG)- Large	
	1100222	Sternum Retractor (SM)- Small	
	1100347	Universal Clamping Assembly <i>Available with 1100010 and 1100020 only</i>	
	1100108	“Original” Heart Stabilizer Kit <i>Available with 1100010 and 1100020 only</i>	
	1100349	Articulated Arm System <i>Available with 1100229 and 1100230 only</i>	

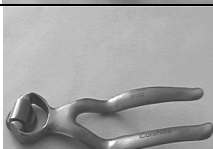
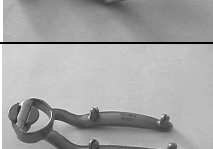
Articulated Arm & Accessories

	Product No.	Product Description	Price (euro)
	1010771	Stabilizer with Pedestals <i>For use with the 1100349.</i>	
	1010940	Stabilizer without Pedestals <i>For use with the 1100349.</i>	
	1010914	Stabilizer with Pedestals – Short <i>For use with the 1100349.</i>	

BEATING HEART CABG SURGERY



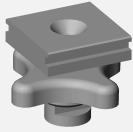

	<p style="text-align: center;">1010904</p>	<p>Compact Stabilizer - Intercostal – Flat For use with the 1100349.</p>	
	<p style="text-align: center;">1011030</p>	<p>Diaphragm Deflector Blade For use with the 1100349.</p>	

Universal Instrument-Mounting Accessories

	Product No.	Product Description	Price (euro)
	<p style="text-align: center;">1010734</p>	<p>UNIVERSAL Adaptor</p>	

BEATING HEART CABG SURGERY

Coronary Vessel Occlusion Products



	Product No.	Product Description	Price (euro)
	1011086	SWIFT-LOOP PLEDGET Forceps	
	1010815	<p>SWIFT-LOOP Vessel Loop with Blunt Needle & PLEDGET</p> <p><i>Silicone Elastomer Loop with Blunt Needle and Pledget, single armed, 19G 25mm x 1/2C needle, 18G x 6" silicone.</i></p> <p><u>Single Use</u></p> <p><i>(Packaged 2 per pouch/10 pouches per box)</i></p>	
	1010643	<p>SWIFT-LOOP Vessel Loop with Blunt Needle</p> <p><i>Silicone Elastomer Loop with Blunt Needle, single armed, 19G 25mm x 1/2C needle, 18G x 12" silicone.</i></p> <p><u>Single Use.</u></p> <p><i>(Packaged 2 per pouch/10 pouches per box)</i></p>	
	1011058	<p>SWIFT-LOOP Vessel Loop for Robotic Surgery with Blunt Needle & PLEDGET</p> <p><i>Silicone Elastomer Loop with Blunt Needle and Pledget, single armed, 19G 25mm x 1/2C needle, 18G x 3" silicone.</i></p> <p><u>Single Use - Double Packaging</u></p> <p><i>(Packaged 1 per pouch/10 pouches per box)</i></p>	

INTERCOSTAL OPCAB SURGERY PRODUCTS

Intercostal Cor-Vasc Systems

	Product No.	Product Description	Price (euro)
	1100240	<i>Intercostal Cor-Vasc System</i>	

Intercostal Cor-Vasc System - Assemblies



	Product No.	Product Description	Price (euro)
	1100235	<i>Detachable Blade Retractor</i> <i>(Blades sold separately)</i>	
	1011116	<i>Detachable Blade Set – 3 cm</i> <i>(Blades sold per pair)</i>	
	1011117	<i>Detachable Blade Set – 5 cm</i> <i>(Blades sold per pair)</i>	
	1011118	<i>Detachable Blade Set – 7 cm</i> <i>(Blades sold per pair)</i>	
	1100347	<i>Universal Clamping Assembly</i>	

INTERCOSTAL OPCAB SURGERY PRODUCTS

Intercostal Cor-Vasc System - Assemblies (continued)





	Product No.	Product Description	Price (euro)
	1010890	<i>Intercostal Stabilizer</i>	

Intercostal Cor-Vasc System - Accessories



	Product No.	Product Description	Price (euro)
	1010904	<i>Compact Stabilizer - Intercostal – Flat</i> <i>For use with the 1010890 or the 1100349.</i>	
	1010959	<i>Compact Stabilizer – Intercostal – Bent</i> <i>For use with the 1010890 or the 1100349.</i>	

VALVE SURGERY PRODUCTS

Cor-Valv Systems



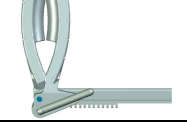

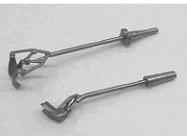
	Product No.	Product Description	Price (euro)
	1100030	Cor-Valv System- Large	
	1100040	Cor-Valv System - Small	
	1100041	Cor-Valv System – Small with Atrial Retractor Only	
	1100042	Cor-Valv System – Large with Atrial Retractor Only	

Cor-Valv System - Assemblies

	Product No.	Product Description	Price (euro)
	1100214	Sternum Retractor (LG)	
	1100222	Sternum Retractor (SM)	
	1100347	Universal Clamping Assembly	
	1100105	Cor-Valv Kit <i>(Includes aortic & atrial tissue retractor)</i>	

VALVE SURGERY PRODUCTS

Cor-Valv System - Accessories

	Product No.	Product Description	Price (euro)
	1100349	Articulated Arm System	
	1011032	Atrial Deflector – Single Blade <i>For use with the 1100349</i>	
	1011180	Cable – Atrial Retractor <u>Single Use</u> <i>(Sold in boxes of 10 individually pouched sterile cables)</i>	
	1011181	Cable – Aortic Retractor <u>Single Use</u> <i>(Sold in boxes of 10 individually pouched sterile cables)</i>	

INTERCOSTAL VALVE SURGERY PRODUCTS

Intercostal Mitral Valve Surgery Systems







	Product No.	Product Description	Price (euro)
	1100300	Intercostal Mitral Cor-Valv System	

Intercostal Mitral Valve Surgery System - Assemblies

	Product No.	Product Description	Price (euro)
	1100235	Detachable Blade Retractor <i>(Blades sold separately)</i>	
	1011116	Detachable Blade Set – 3 cm <i>(Blades sold per pair)</i>	
	1011117	Detachable Blade Set – 5 cm <i>(Blades sold per pair)</i>	
	1011118	Detachable Blade Set – 7 cm <i>(Blades sold per pair)</i>	
	1100347	Universal Clamping Assembly	
	1100352	Intercostal Atrial Retractor <i>(includes 42mm blades P/N 1011735 and tube 1011777)</i>	



INTERCOSTAL VALVE SURGERY PRODUCTS

Intercostal Mitral Valve Surgery System - Accessories

	Product No.	Product Description	Price (euro)
	1011699	<i>Linkage Assembly – TMVR 60 mm</i>	
	1011735	<i>Linkage Assembly – TMVR 42 mm</i>	
	1011714	<i>Linkage Assembly – Aortic Intercostal</i>	
	1011777	<i>Intercostal retractor tubing assembly</i>	
	1011755	<i>Retractor obturator</i>	
	1011739	<i>Cable for Intercostal Atrial Retractor (Box of 10 individually pouched STERILE cables) SINGLE USE</i>	



PEDIATRIC HEART SURGERY

Pediatric Retractors





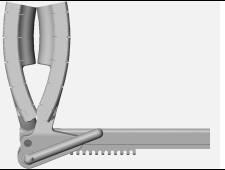

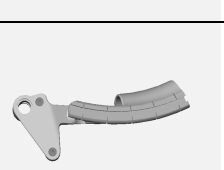
	Product No.	Product Description	Price (euro)
	1100210	<i>Pediatric Swivel Retractor - Infant</i>	
	1100211	<i>Pediatric Swivel Retractor - Neonate</i>	

SUB-ASSEMBLIES

	1100214	<i>Sternum Retractor (LG)</i>		
	Product No.	Product Description	Price (euro)	
	1011378	<i>Spreader Arm – rack side – large</i>		
	1010807	<i>Spreader Arm – crank side – large</i>		
	1011713 <small>(interchangeable with 1010619)</small>	<i>Pinion</i>		

	1100222	<i>Sternum Retractor (SM)</i>		
	Product No.	Product Description	Price (euro)	
	1011379	<i>Spreader Arm – rack side – small</i>		
	1010900	<i>Spreader Arm – crank side – small</i>		

SUB-ASSEMBLIES

	1100108	Heart Stabilizer Kit		
	Product No.	Product Description	Price (euro)	
	1010395	<i>Push-Type Stabilizer – right angle</i>		
	1010396	<i>Push-Type Stabilizer – obtuse angle</i>		
	1010397	<i>Pull-Type Stabilizer – left hand bend</i>		
	1010398	<i>Pull-Type Stabilizer – right hand bend</i>		
	1011713 (interchangeable with 1010619)	<i>Pinion</i>		

SUB-ASSEMBLIES

	1100349	Articulated Arm Assembly		
	Product No.	Product Description	Price (euro)	
	1010937	Jaw and Cable Assembly – articulated arm		
	1010937A	Cable – refurbishment <i>(Replace the cable only)</i>		
	1010937B	Cable Assembly – refurbishment <i>(Replace the vertebrae and the cable)</i>		
	1011592	Cam Lock Assembly		
	1011593	Post Assembly		



SUB-ASSEMBLIES

	1100235	<i>Detachable Blade Retractor</i> <i>(Blades sold separately)</i>		
	Product No.	Product Description		Price (euro)
	1011024	<i>Detachable Blade Retractor – crank side</i>		
	1011381	<i>Detachable Blade Retractor – rack side</i>		
	1011713 <small>(interchangeable with 1010619)</small>	<i>Pinion</i>		



SUB-ASSEMBLIES

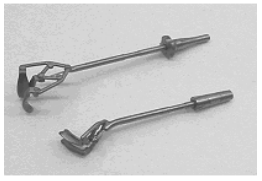
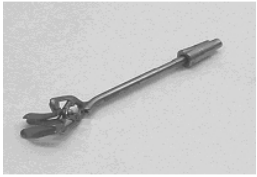
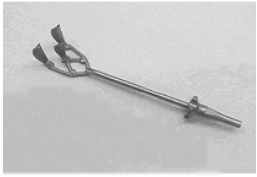

	<p>1010890</p>	<p><i>Intercostal Stabilizer</i></p>		
	<p>Product No.</p>	<p>Product Description</p>	<p>Price (euro)</p>	
	<p>1010752</p>	<p><i>Cable Tension Adjuster – articulated arm</i></p>		
	<p>1011080</p>	<p><i>Cam Lock Assembly</i></p>		
	<p>1010892</p>	<p><i>Cable Assembly</i></p>		
	<p>1010921</p>	<p><i>Straight Tubular Housing</i></p>		
	<p>1010954</p>	<p><i>Bent Tubular Housing</i></p>		
	<p>1010959</p>	<p><i>Compact Stabilizer – Intercostal - Bent</i></p>		
	<p>1011132</p>	<p><i>Trocar Tip - .156 inch</i></p>		
	<p>1011069</p>	<p><i>Cable Hook</i></p>		

SUB-ASSEMBLIES

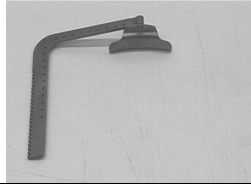
	1100105	Cor-Valv Kit (Series LG) Assembly		
	Product No.	Product Description	Price (euro)	
	1010676	<i>Housing – aortic retractor</i>		
	1010684	<i>Housing – atrial retractor</i>		
		Cor-Valv Tissue Retractor – Special Order		
	Product No.	Product Description	Price (euro)	
	1010729	<i>Housing – atrial retractor – Trans-septal approach</i>		

SUB-ASSEMBLIES

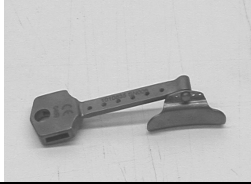
	1100210	<i>Pediatric Swivel Retractor - Infant</i>		
		Product No.	Product Description	Price (euro)
		1010842	<i>Crank side for Infant Retractor</i>	
		1010844	<i>Rack side for Infant Retractor</i>	
		1010850	<i>Pinion for Pediatric Retractors</i>	

	1100211	<i>Pediatric Swivel Retractor - Neonate</i>		
		Product No.	Product Description	Price (euro)
		1010835	<i>Crank side for Neonate Retractor</i>	
		1010837	<i>Rack side for Neonate Retractor</i>	
		1010850	<i>Pinion for Pediatric Retractors</i>	

INDEX

1010395 _____	18	1011117 _____	10, 14
1010396 _____	18	1011118 _____	10, 14
1010397 _____	18	1011132 _____	21
1010398 _____	18	1011180 _____	13
1010643 _____	8	1011181 _____	13
1010676 _____	22	1011184 _____	13
1010684 _____	22	1011185 _____	13
1010729 _____	22	1011378 _____	17
1010734 _____	7	1011379 _____	17
1010752 _____	21	1011381 _____	20
1010771 _____	6	1011592 _____	19
1010807 _____	17	1011593 _____	19
1010815 _____	8	1011699 _____	15
1010835 _____	23	1011713 _____	17, 20
1010837 _____	23	1011714 _____	15
1010842 _____	23	1011735 _____	15
1010844 _____	23	1011739 _____	15
1010850 _____	23	1011755 _____	15
1010890 _____	11, 21	1011777 _____	15
1010892 _____	21	1100010 _____	5
1010900 _____	17	1100020 _____	5
1010904 _____	7, 11	1100030 _____	12
1010914 _____	7	1100040 _____	12
1010921 _____	21	1100041 _____	12
1010937 _____	19	1100042 _____	12
1010937A _____	19	1100105 _____	12, 22
1010937B _____	19	1100108 _____	6, 18
1010940 _____	6	1100210 _____	16, 23
1010954 _____	21	1100211 _____	16, 23
1010959 _____	11, 21	1100214 _____	6, 12, 17
1011024 _____	20	1100222 _____	6, 12, 17
1011030 _____	7	1100229 _____	5
1011032 _____	13	1100230 _____	5
1011058 _____	9	1100235 _____	10, 14, 20
1011069 _____	21	1100240 _____	10
1011080 _____	21	1100300 _____	14
1011086 _____	8	1100347 _____	6, 10, 12, 14
1011090 _____	8	1100349 _____	6, 13, 19
1011114 _____	8	1100352 _____	14
1011116 _____	10, 14		